

**INTERIO**

**PELLET BOILER**

18/25



**USER AND MAINTENANCE MANUAL**

**ThermoFLUX**

Dear users,  
Congratulations on choosing a boiler from the production range of ThermoFLUX d.o.o. We kindly ask all individuals operating and handling the boiler to thoroughly study this manual and adhere to the instructions for use and safety. Always keep the manual in a location near the boiler. Due to the constant improvement and development of our products, some images or illustrations in this manual may differ.

## IMPORTANT INFORMATION

The initial commissioning and user training must be performed by a service technician authorized by ThermoFLUX d.o.o. or the importer; otherwise, the warranty will not be valid.



### DECLARATION OF CONFORMITY EU (DoC)

In accordance with ISO/IEC Guide 22 and EN 45014



Manufacturer ..... : **ThermoFLUX d.o.o.**  
**Bage 3, 70101 Jajce**  
**Bosna i Hercegovina**

Name / Mark.....: Heating pellet boilers

Type / Model.....: INTERIO 18; INTERIO 25

To which this declaration relates, in accordance with the following normative documents:

Directives: MD 2006/42/EC  
LVD 2014/35/EU  
EMCD 2014/30/EU  
RoHS 2011/65/EU

Applied harmonized standards: EN 303-5:2021; EN ISO 12100:2010;  
EN 287-1: 2011, EN 61000-6-2; EN 61000-6-3; EN 60335-1; EN 60335-2-102;  
EN 62233; EN 50581

Other specified standards and specifications: EN 55014-1:2006/A2:2011;  
EN 55014-2:1997/A2:2008; EN 61000-3-2:2006/A2:2009; EN 61000-3-3:2008;  
EN 10204:2004; EN ISO 7000 :2004; Art. 15a B-VG

Applied procedures for assessing compliance: Modul B-D

Limit values for emissions of combustion products (class): 5

Certificates that are issued: Report on type testing no. PL-22022-1-P; PL-22022-2-P

Accredited body: TU Wien; Prüflabor für Feuerungsanlagen – Inst. f.  
Verfahrenstechnik, Umwelttechnik und Techn.  
Biowissenschaften Getreidemarkt 9/ 166; A-1060 Wien

We hereby declare that the above named product concept and method of preparation, in accordance with safety and security standards that comply with the above directives and standards.

In doing all operating conditions and terms of use in accordance with the attached instruction manual and technical documentation.

When only one change to the product which is not in agreement with us, this declaration loses its importance.

Last name, first name and title of signatory:

Jajce, 25.12.2024

.....  
Place and date of issue

 *Direktor Tomislav Ladan*  
.....  
Signature, Seal

# CONTENT:

<b>Content:</b>	3	Language selection	19
<b>Notes on the manual</b>	4	Stand by status	19
Simple and safe operation	4	Stand by mode with a built-in water	
Technical changes	4	temperature sensor	19
Copyright	4	Stand by mode with a connected	
Safety measures	4	room thermostat	20
Warning signs	4	The buzzer option	20
Other warnings	5	Filling the spiral	20
<b>General overview of the boiler</b>	6	Boiler status	20
GSM modem	6	Technical settings	20
Wi-Fi modem for internet connection	6	<b>Ignition and shutdown</b>	21
Technical specifications	7	Ignition	21
<b>Safety instructions</b>	8	Shutdown	21
Proper use	8	Power setting adjustment	21
Basic principles	8	Water temperature adjustment	21
Local standards	9	Modulation	22
Safety instructions for the boiler room	9	<b>Cleaning and maintenance</b>	22
Safety devices on the boiler	9	Cleaning of the burner	22
<b>Boiler installation</b>	9	Daily cleaning and inspection	22
Conditions for installation	10	Periodic cleaning of the tubular heat	
Chimney and flue gas pipes	10	exchanger	23
Methods of connection	12	Emptying the flue gas chamber of ash	23
Electrical connection	12	Removing the side panel	24
<b>Operation of the boiler</b>	14	<b>Alarms</b>	25
Control panel and button layout	14	<b>Guarantee</b>	26
Operating principle	15	Guarantee period	26
Schematic representation of the menu on the		Warranty conditions/terms	26
control system	16	Exclusion from the warranty	26
Setting the clock	18	<b>Postponement</b>	26
Setting programmed ignition		Boiler removal & disposal instructions	26
and shutdown	18	<b>EU LABEL</b>	26

## NOTES ON THE MANUAL

### Simple and Safe Operation

This manual is an integral part of the Interio fireplace and contains important information for its proper and safe operation. By following the instructions in this manual, the fireplace will function correctly, helping you avoid hazards, repair costs due to malfunctions, and extending the fireplace's service life. All individuals operating the fireplace must adhere to the instructions provided in this manual.

### Technical Changes

ThermoFLUX d.o.o. continuously develops and improves its boilers. The information provided in this manual was accurate at the time of printing.

All details in this manual regarding standards and regulations should be verified and compared with the installed fireplace before use.

We reserve the right to make any changes that may result in deviations from the technical details and illustrations shown in this manual.

### Copyright

Copying or reproducing any content from this manual is strictly prohibited! Written permission from ThermoFLUX d.o.o. is required for any copying, storage in data systems, or transmission via electronic, mechanical, or any other means, as well as for reproducing and publishing parts or the entire manual.

### Safety measures

The boiler is manufactured according to all legally prescribed standards and norms. The boiler consists of several components that are constantly under a 230 V ~AC voltage. It is strictly forbidden to perform any interventions or repairs while the boiler is in operation. All assembly, replacement, and repair interventions must only be carried out by skilled and qualified personnel.

## WARNING SIGNS

	<b>RISK OF ELECTRIC SHOCK</b> Work in areas marked with this sign may only be performed by a qualified electrician.
	<b>WARNING!</b> Warning for hazardous locations and actions. Non-compliance may result in life-threatening injuries.
	<b>RISK OF SUFFOCATION DUE TO CARBON MONOXIDE.</b>
	<b>WARNING!</b> Risk of bodily injury. Work in locations marked with this sign may result in bodily injuries.
	<b>WARNING!</b> Hot surfaces. Work in locations marked with this sign may result in burns.
	<b>WARNING!</b> Risk of fire. Work in locations marked with this sign may result in ignition.
	<b>WARNING!</b> Risk of freezing. Work in locations marked with this sign may result in freezing.
	Instructions for Proper Waste Disposal.
	<b>Access Forbidden!</b> Access to the room must be restricted to unauthorized persons, especially children.

## OTHER WARNINGS

	Never touch hot surfaces!
	Hot parts of the fireplace, flue pipes, and heating pipes can cause severe burns!
	Use gloves when working with the fireplace. Maintain the boiler only according to the instructions in the manual. Insulate the flue pipes and avoid possible contact.

	Do not open the ash cleaning doors during operation.
	Opening the ash cleaning doors and the control doors on the fireplace may cause the fireplace to stop working, result in injuries, damage, and leakage of flue gases.
	Open the ash cleaning doors only during regular cleaning and maintenance.

	<b>NEVER DISCONNECT THE BOILER FROM THE ELECTRICAL NETWORK DURING FIREPLACE OPERATION!</b>
	The connection to the electrical network should be with a permanent connection to avoid the possibility of accidental disconnection.

	Although the boiler is protected with multiple levels of safety, intentionally disconnecting it from the electrical network may cause unforeseen malfunctions.
---	--

### Overheating of the system.

If the heating system overheats despite all safety elements, the following steps should be taken.

- Do not open the fireplace doors.
- Turn off the boiler by pressing the button  for 3 seconds.
- Open all heating circuits and turn on all pumps (the regulation on the fireplace controls this automatically).
- In the building, open all available valves on the radiators / distributors.

**If the temperature in the system does not decrease, contact an authorized service technician.**

### Smoke smell

**Flue gases can cause poisoning!**

- Do not open the boiler doors.
- Turn off the boiler by pressing the button  for 3 seconds.
- Ventilate the room where the boiler is located.
- Leave the room and close the doors.



### Fire in the room

In case of fire or a fire breakout in the room:



- Turn off the boiler by pressing the button  for 3 seconds
- For extinguishing, we may use type AB powder fire extinguishers.

## GENERAL OVERVIEW OF THE BOILER

The Interio 18 and 25 boilers have a modern design, intended for users who do not have enough space for installing boilers with large pellet storage tanks. The boiler is compact and requires only 1m<sup>2</sup> for installation. With a 50 kg pellet storage capacity, digital regulation with a seven-day programmer, cast iron combustion chamber, circulation pump, expansion vessel, and safety valve, it is easy to install and use.

The boilers feature a vertical tube heat exchanger and are designed to be connected to a central heating system. The boilers are thermally insulated, minimizing heat losses to the surrounding space.



### Additional equipment that can be installed (not supplied with the boiler):

#### GSM modem



Using a mobile phone and sending the appropriate SMS message, the following functions can be performed:

- Setting preset phone numbers
- Setting the communication language between the modem and the phone
- Turning on the fireplace/boiler
- Turning off the fireplace/boiler
- Changing the preset temperature
- Changing the operation power
- Reading the status of the fireplace/boiler

#### Wi-Fi modem for internet connection.



Compatible with Android, iOS, and Windows devices. The user can have full control over the fireplace via the app (turning it on/off, changing power, temperature, or programming it).

## Technical specifications

	Unit of measurement	Interio 18	Interio 25	
1	Boiler weight	kg	237	256
2	Operating power range	kW	5 - 18	7-25
3	Water content in the boiler	L	33	40
4	Minimum flue draft	Mba/Pa	0,05/5	0,05/5
5	Supply/return pipe	inch	1"	1"
6	Efficiency	%	89,7	90,7
7	Flue gas temperature	°C	160	160
8	Maximum operating temperature	°C	80	80
9	Maximum operating pressure	bar	2,5	2,5
10	Height to the center of the chimney	mm	278	278
11	Boiler depth	mm	790,5	790,5
12	Boiler width	mm	615	615
13	Boiler height	mm	1280	1280
14	Chimney diameter	mm	80	80
15	Height of the supply/return	mm	641/151	641/151
16	Amount of pellets in the storage	kg	42	42
17	Electrical connection	V, Hz	230V, 50Hz	230V, 50Hz
18	Nominal/max electrical energy consumpti.	W	100/420	100/420
19	Min/max water temperature at the outlet.	°C	55/80	55/80
20	Min/max pellet consumption	kg/h	1,5-3,5	1,3-4,8
21	Fuel	-	Pellet	Pellet
22	Chimney outlet (top/rear)		back	back

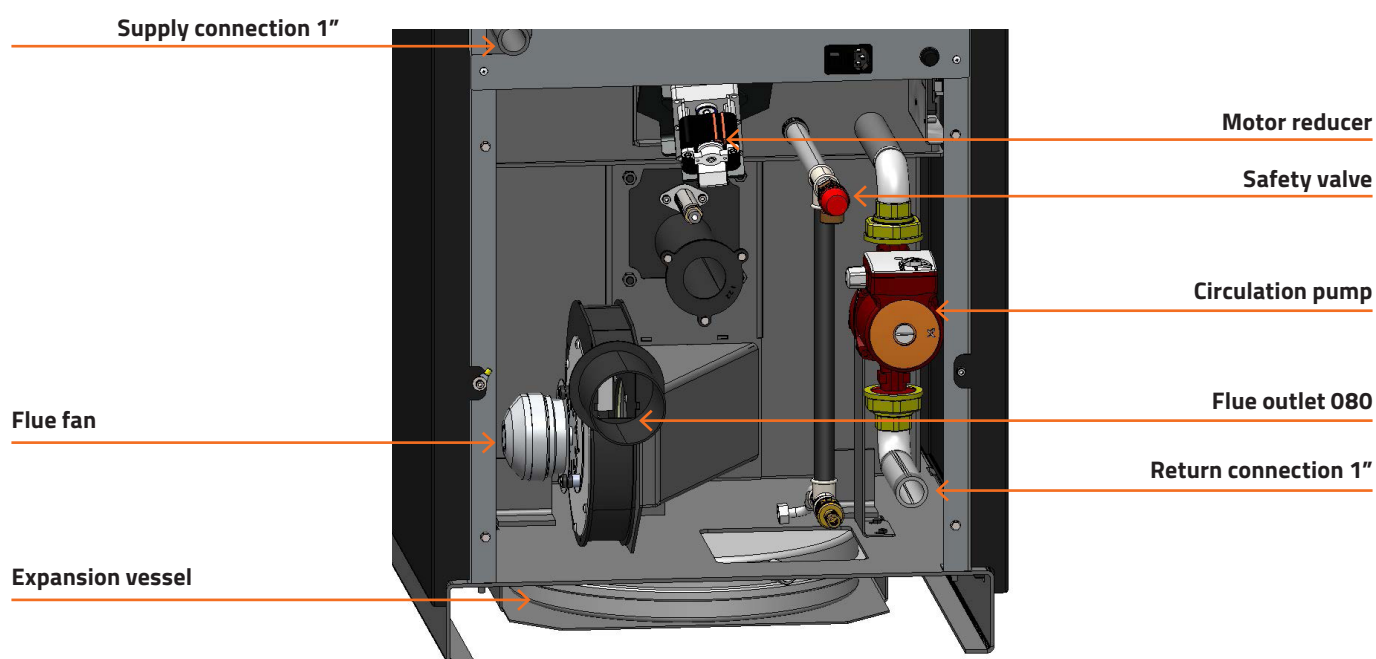

# SAFETY INSTRUCTIONS

## PROPER USE

### Basic principles

The Interio boiler is designed and tested in compliance with the safety provisions derived from the EN 303-5:2012 directive; however, improper use may result in physical injuries, potentially leading to the death of the user and/or third parties, as well as damage to the boiler itself or other material assets.

### Boiler operation

The boiler may only be used when in proper working condition. Use the boiler as described in this manual. Familiarize yourself with the safety measures and potential hazards. Eliminate all deficiencies and malfunctions that could affect safety. Children aged 8 and older, individuals with reduced physical, motor, or mental abilities, and those lacking experience or proper training may use such appliances if they are supervised or provided with instructions on the safe use of the appliance and made aware of the associated hazards. Children must not play with such appliances. These appliances must not be cleaned or subjected to user maintenance by children without appropriate supervision.

### Boiler use

The boiler is intended for the combustion of wood pellets. Any other use is improper. The manufacturer will not assume responsibility for any damage caused by improper handling. Proper use involves maintaining the installed boiler, operations, and maintenance conditions as prescribed by the manufacturer. The user may only enter or change those values specified in this manual. Any other parameter values will affect the control program and the operation of the boiler, which may ultimately lead to a malfunction or improper operation.

### Modifications to the stove

Any modifications to the boiler and equipment supplied with it are prohibited. Disabling safety features is forbidden. The manufacturer will not honor any warranty if the user or a third party performs unauthorized interventions on the boiler and the equipment that comes with it.

**The boiler may only be used for the purpose for which it was designed. The manufacturer does not accept any responsibility for damage to people, animals, or property resulting from errors during installation, improper adjustment and maintenance, or improper use of the stove.**



### Fuel that can be used in stoves

**The boiler is intended only for the combustion of wood pellets with a diameter of 6 mm and a length of 10 to 30 mm.**

### What is a pellet?

A pellet is made from wood, preferably from the core of the trunk with as little bark as possible. The bark contains the highest moisture, dust, and impurities that the wood collects during growth, which is why it has a lower caloric value than the core, and the issue is that it leaves deposits during combustion. The ideal wood for pellet production is one that burns neither too long nor too short, creating a long-lasting ember. Pellets are made from waste sawdust (usually in a ratio of 20-40% softwood + 60-80% hardwood) under high pressure in special machines, which causes densification. It is not allowed to use any additives or glues during pellet production. Pellets contain minimal moisture and ash content and have the maximum energy value for the specific type of wood from which they are made.

### Recommended wood pellet and standards

The quality of pellets is derived from the Pellet C1 Standard according to EN 303-5:2012 Table 7; moisture content less than 12%, in accordance with DIN 51731 - HP 5, DINplus certification program, and ÖNORM M 7135 - HP 1.

**Special attention should be given to the quality of wood pellets. Poor-quality pellets can cause improper operation of the stove.**

### Prohibited fuels

Pellets that do not comply with the standards from paragraph 3.2.1 of this manual are not allowed to be burned in the Interio boiler.

### Mandatory information

All individuals operating the stove must read the manual before using it, especially the "Safety Instructions" section.

This applies particularly to those who occasionally work on the stove, such as cleaning and maintenance.

This manual should always be kept close by, near the installed stove. kamina.

## Local standards

**During installation and assembly, all local laws, standards, and regulations in effect in the country where the boiler is being installed must be followed.**

Upon the first installation of the boiler or in the case of modifications to the central heating system, it is necessary to notify the relevant authority responsible for inspection and obtain all required permits.

## Safety instructions for the boiler room

The boiler room must be constructed in accordance with applicable regulations, especially regarding fire safety. Flammable materials, cleaning agents, and similar substances must not be stored in the boiler room.

**The area where the boiler is installed must be frost-resistant.**

The boiler must not be exposed to cold and freezing. Extreme cold can cause improper operation and unexpected behavior of electronic components. For normal regulation operation, a temperature of 0°C to 50°C is required.

## Air intake opening

The boiler requires fresh air for pellet combustion and normal operation. The boiler room where the boiler is installed must have an opening for fresh air intake. The recommended minimum dimensions for the opening are 30x10 cm.

## Safety devices on the boiler

**The boiler is equipped with safety systems that, in the event of unforeseen situations, serve to interrupt the power supply and thus stop the boiler's operation.**

**Microprocessor control on the boiler:** intervenes directly, shuts down the boiler until it cools down, and displays an error on the screen. This occurs in the event of a flue gas fan failure, feeder motor failure, or failed ignition.

**Fuse:** A fast fuse that protects the boiler from significant voltage fluctuations and short circuits within the boiler.

**Temperature limiter (STB):** intervenes by interrupting the electrical circuit, causing the boiler to stop operating.

## BOILER INSTALLATION

**The system startup is performed by personnel authorized by ThermoFLUX d.o.o., or the importer.**

**The warranty will not be valid if the boiler is not started up by an authorized service technician.**

The commissioning includes instructions on basic operations and maintenance of the boiler. The service technician authorized for the initial startup must monitor the operation for at least one full working cycle. In some countries, it is mandatory for the chimney sweep or an authorized inspection person to review and approve the initial startup.



Risk of material and bodily damage due to improper commissioning. If the commissioning is carried out by an unqualified person, it may result in damage to the stove and heating system.

**NOTE: Grounding connection to the boiler body is mandatory for protection against high voltage (lightning strike, etc.). Otherwise, the warranty on electrical components will not be valid.**

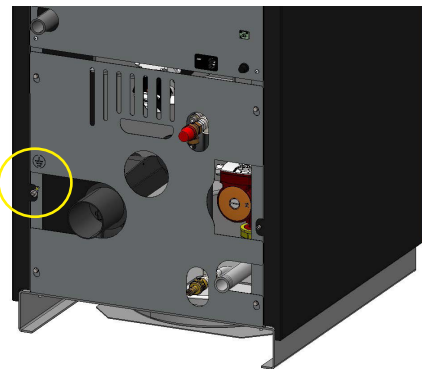

STB

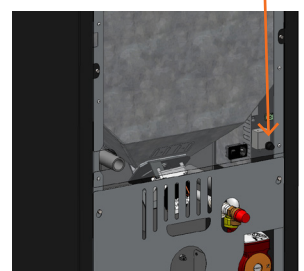
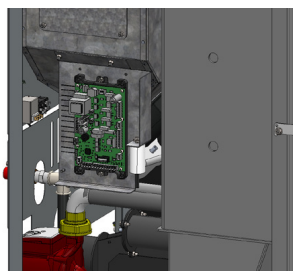

## Conditions for installation

The following conditions must be met before the system can be put into operation.

The boiler installation must be done according to regulations with a minimum distance of 50 cm from the sides and 40 cm from the rear of the boiler. The distance in front of the boiler must be at least 100 cm.

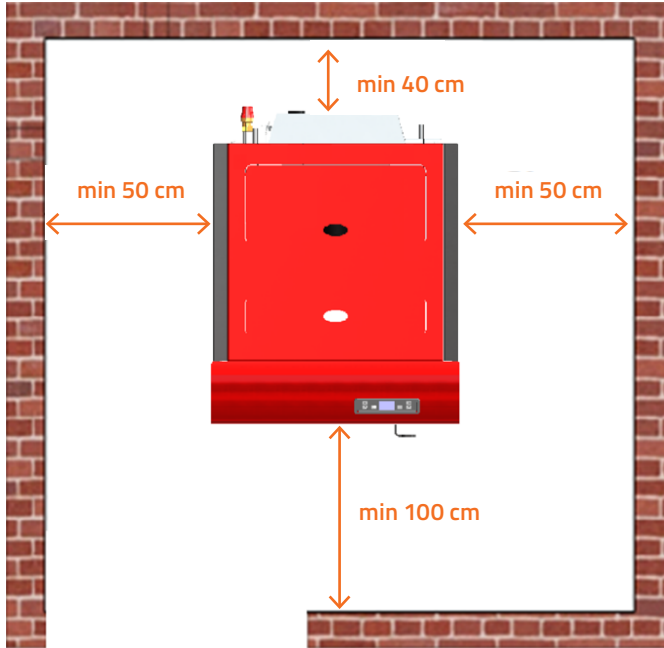

## Disconnect the main power supply

**Always disconnect the main power supply before performing any work**

## Check the mechanical connections

- Check if all components are properly connected.
- Check if all mechanical components are properly secured.

## Check the hydraulic connections

- Check if the safety equipment is properly connected.
- After completing the work, fill the system and wait for an hour to check all connections.

The boiler comes with a built-in expansion vessel and can only be connected to a closed heating system.

## Chimney and flue gas pipes

**The boiler must be connected to the chimney. The chimney should be designed and built in accordance with the EN 13384-1 standard. The chimney must be thermally insulated to prevent condensation formation.**

The flue gas discharge must comply with applicable regulations regarding both the chimney dimensions and the materials used for its construction. The chimney must have a cleaning opening at the lower part.

The chimney underpressure should be a minimum of 5 Pa and a maximum of 20 Pa. The underpressure is necessary to ensure that, in the event of a power failure or fan shutdown, the gases produced in the stove are naturally expelled outside.

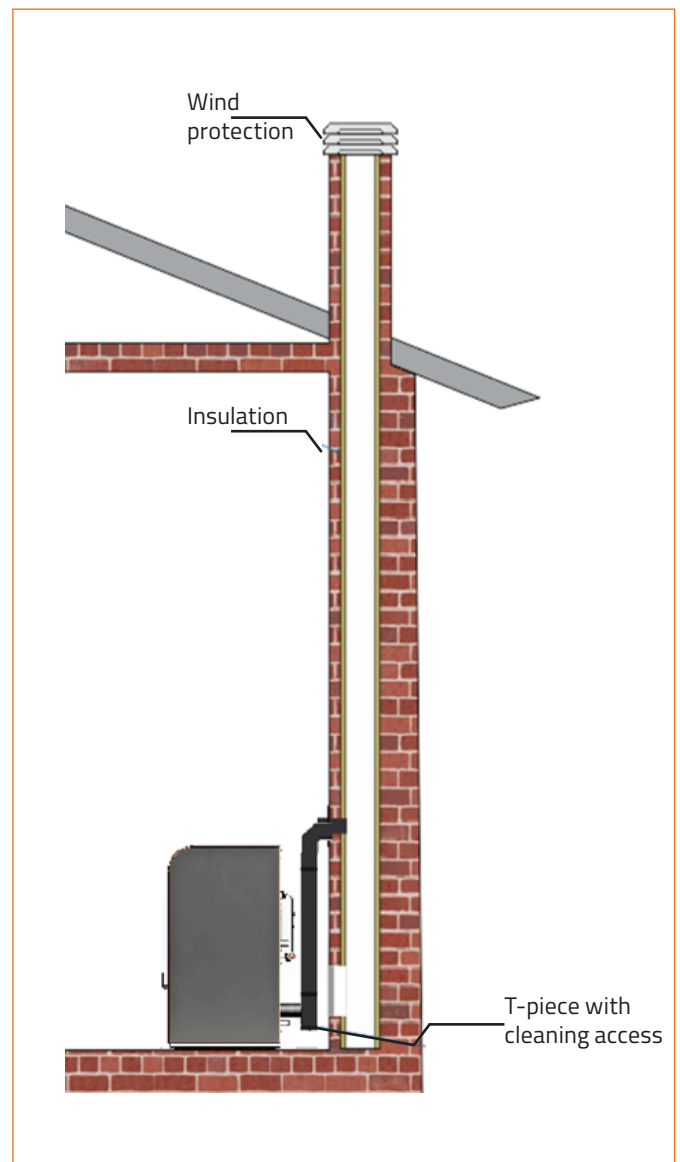

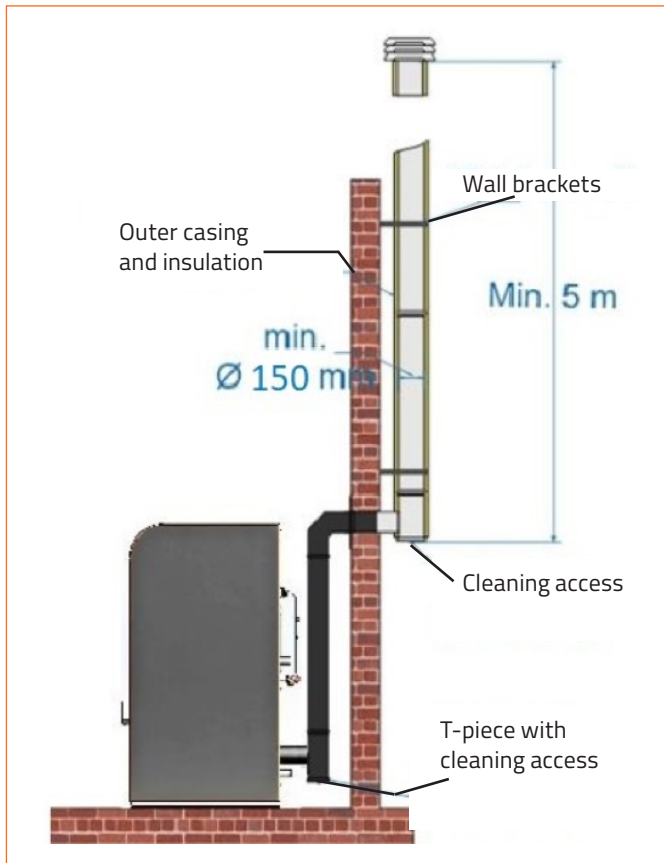

The internal cross-section of the chimney should not be smaller than 150 mm, and the height should be at least 5 meters from the connection point. A cap at the top is recommended as protection against wind and weather conditions. The internal cross-section of the flue pipes should be smooth, and all joints must be sealed hermetically. Horizontal sections should be avoided as much as possible. If used, horizontal sections should have a slope of at least 3% upwards. The total length of the flue pipes should be kept to a minimum and, in any case, should not exceed 2 meters, with the possibility for cleaning and removal of accumulated ash. The connection to the chimney should be made with a maximum of two flue elbows.

For the boiler to operate properly, a constant underpressure is required. When the boiler is running at reduced power, the flue gas temperature is low, which can lead to condensation. Therefore, it is crucial for the chimney to be well-insulated.

Flue pipes should be made of non-combustible materials that are suitable and durable for combustion products and their potential condensation. In any case, parts or areas that may catch fire, such as wooden planks, beams, or fabrics, must be adequately protected with non-combustible materials.



**FLEXIBLE METAL HOSES MUST NOT BE USED AS FLUE PIPES!**

**ALL PARTS OF THE FLUE GAS PIPE MUST BE SECURE AND REPLACEABLE TO ALLOW FOR INTERNAL CLEANING. AVOID MULTIPLE HORIZONTAL DEVIATIONS AND ANGLES.**

If the chimney creates too much underpressure (over 20 Pa), we can adjust it in several ways. One method, though less recommended, is to slightly open the cleaning doors.

Our recommendation is to install a draft regulator (German - Zugregler, English - draft regulator).



### The boiler must not be connected:

- to a chimney or flue pipe that is connected to and used by another heat source (gas boilers, wood boilers and stoves, pellet boilers and stoves)
- to ventilation systems.

When connecting to the chimney, it must be done with pipes of 80 mm diameter and temperature-resistant seals. It is recommended to install a T-piece with an access for cleaning or an elbow after the exit from the stove, with a flue pipe of at least 0.5 meters in length, and only then connect it to the chimney. The connection must not be made directly into the chimney without flue elbows.

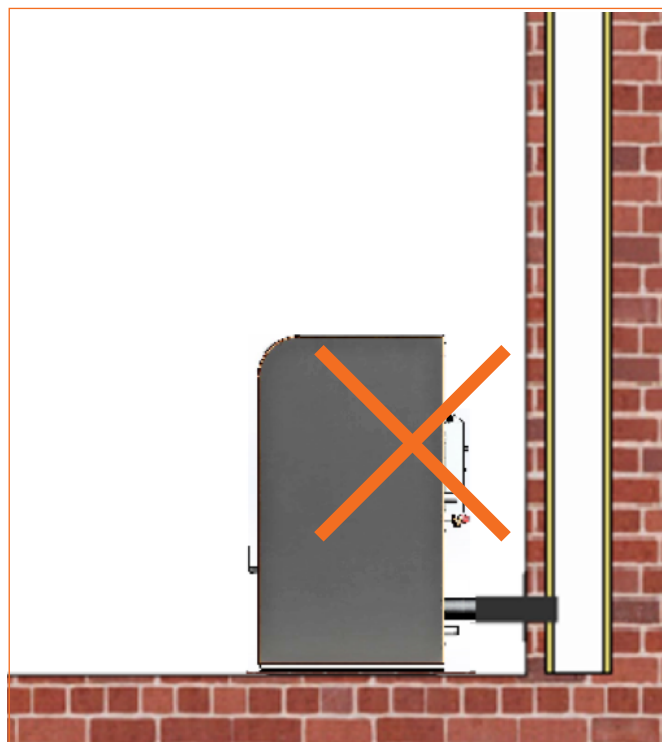

# Methods of connection

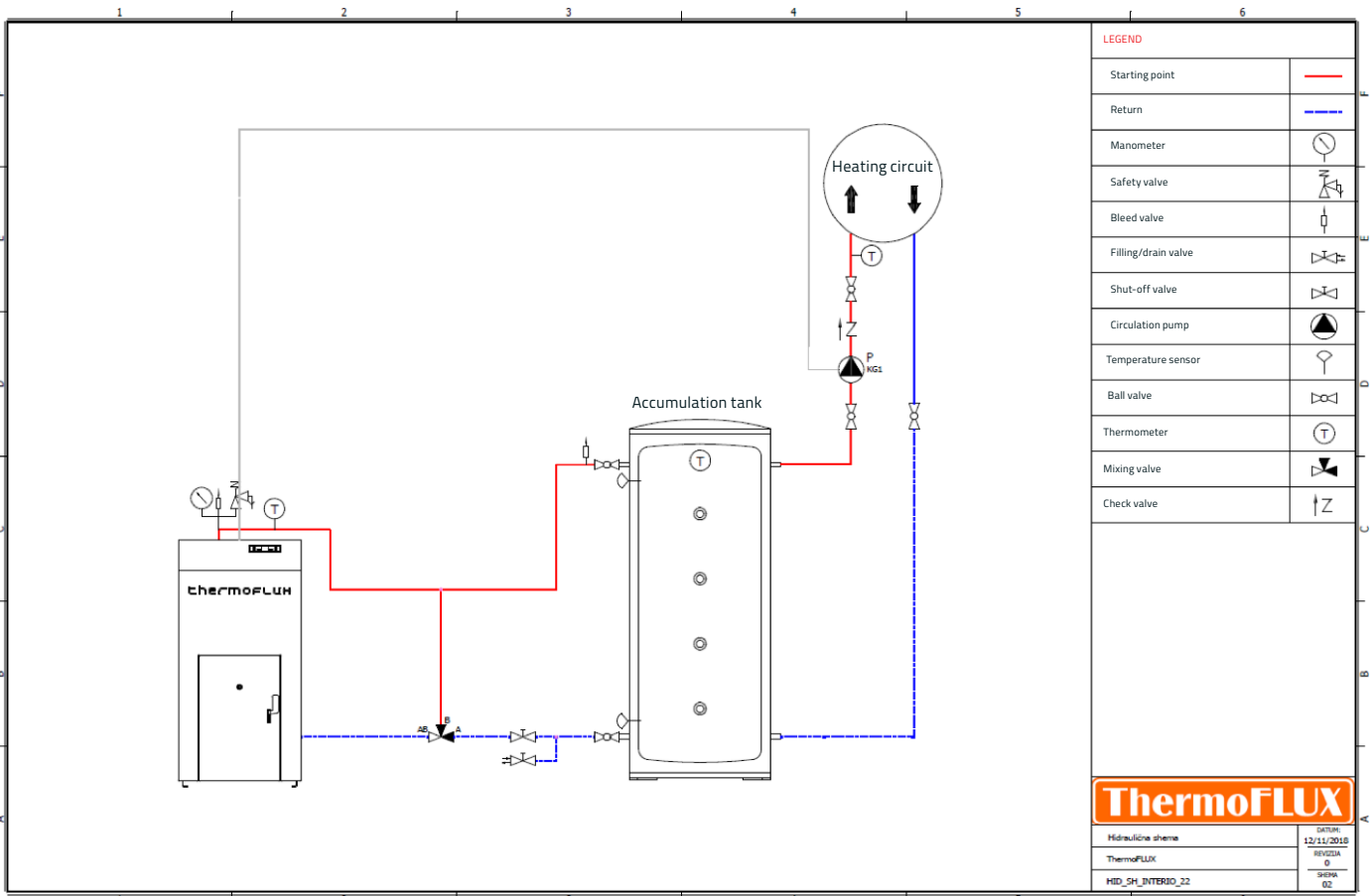
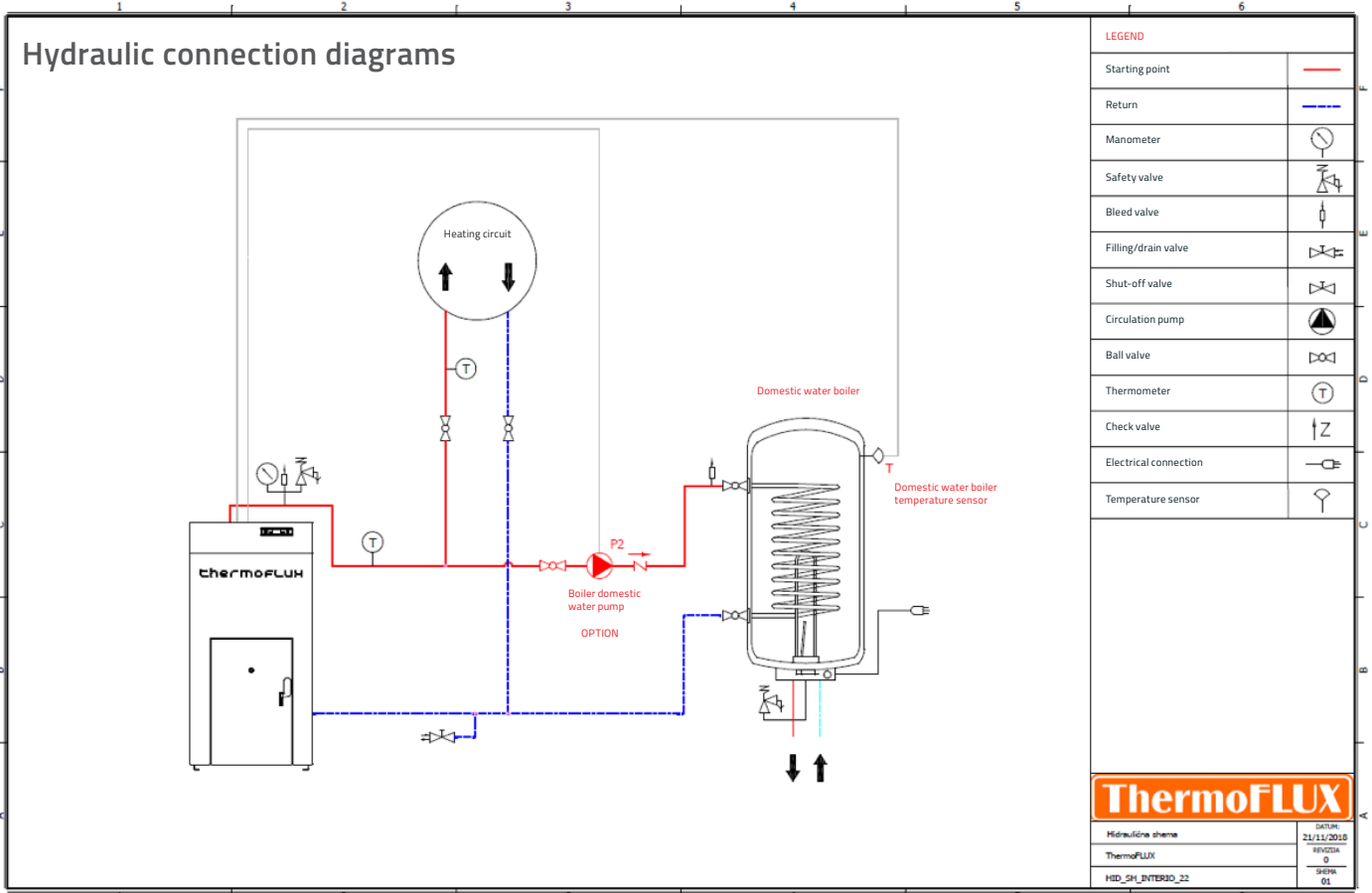

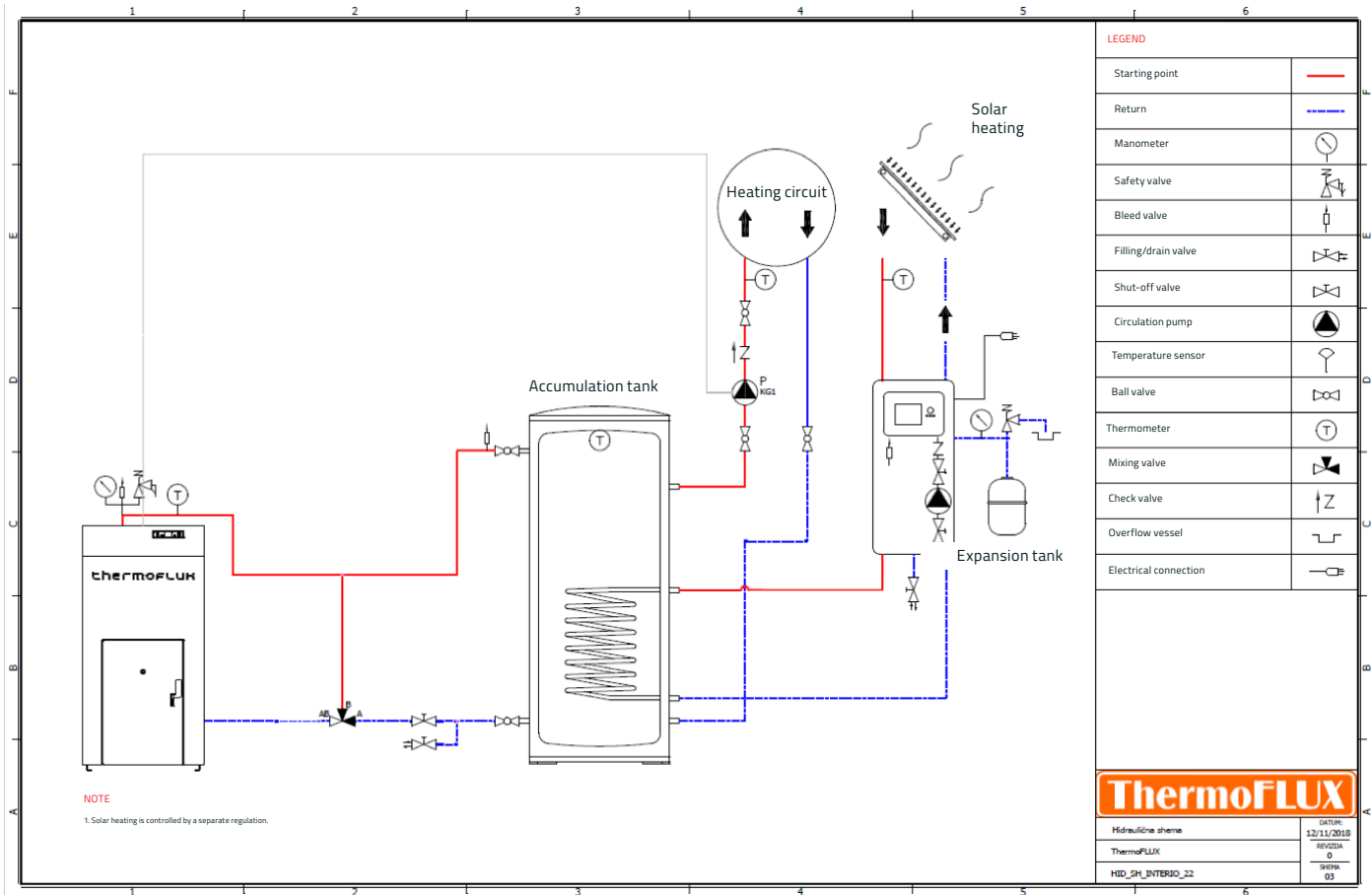

## Electrical connection

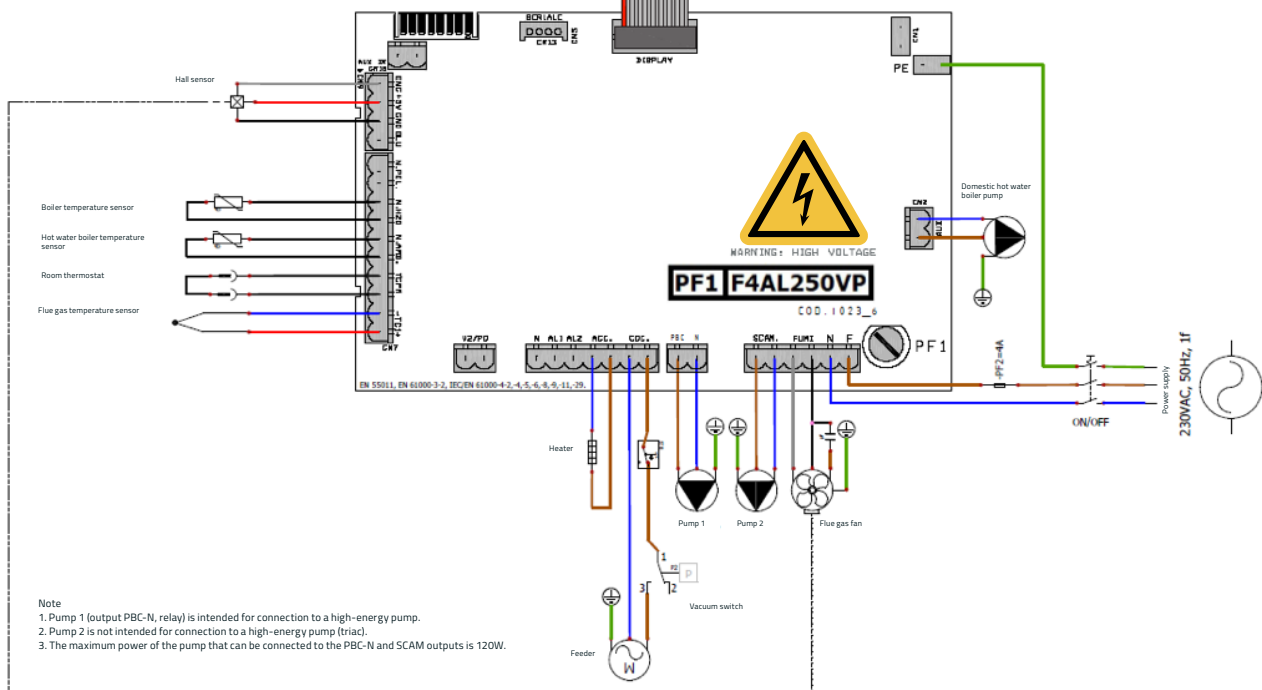
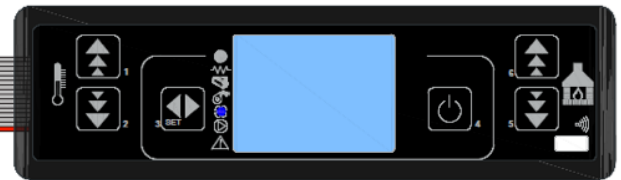

The boiler comes with a built-in circulation pump, expansion vessel, and safety valve. On the back of the boiler are connection points for:

- Power supply 230 VAC, 50 Hz
- Room thermostat

## Power supply

The boiler must be connected to the electrical network of 230 V, 50 Hz via a separate 6–10 A (fast) fuse.

## Room thermostat

The user has the option to place the thermostat in a different room from where the boiler is installed. The operation of the boiler with an external thermostat connected to the room thermostat terminal may vary depending on whether the STAND BY function is activated. The room thermostat terminal is factory-equipped with a bridging connection, meaning its contact is closed.

It is recommended that the installation and connection of the room thermostat be performed by an authorized technician.

**The room thermostat is not an integral part of the boiler's control system. In case the user encounters issues with the room thermostat, such faults and problems are not covered under the warranty.**

## OPERATION OF THE BOILER

### Control panel and button layout

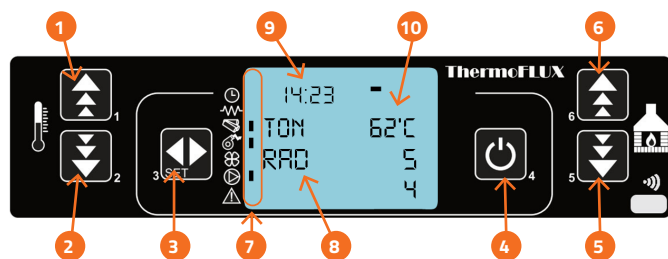

BUTTON	DESCRIPTION
1	Increase in temperature and program functions (setting day, time...)
2	Decrease in temperature and program functions (setting day, time...)
3	Change – program confirmation
4	ON / OFF turning on and off, exit from the program
5	Power reduction, navigating through the menu
6	Power increase, navigating through the menu

BUTTON	MARKING	IF VISIBLE	
7		Watch	Programmed activation active
		Heater	Heater active
		Pellet dosing	Feeder active
		Flue gas fan	Fan active
		Primary air fan	Fan active
		Circulation pump	Pump active
		Alarm indicator	Alarm activated

BUTTON	DESCRIPTION
8	Operating information
9	Hour
10	Water temperature indicator in the stove

The regulation on “Interio” pellet boilers is the central electronic component. It consists of the main control module and a control unit with a display located on the body of the boiler. The control unit allows you to manage the boiler’s functions and check the information about the current state of the boiler.

The regulation, thanks to the ability to operate at five different power levels, can automatically adjust to meet the needs for increasing or decreasing thermal energy.

If there is a need for increased power, the regulation registers this and increases the operating power, which causes increased pellet dosing and, proportionally, a higher amount of air being blown into the combustion chamber.

When the desired temperature is reached (the thermal energy needs are met), the regulation reduces the operating power (modulates operation), or when the room thermostat signals that the set temperature in the room has been reached, the boiler is turned off (if the STAND-BY mode is switched to ON).

## Operating principle

When we press the start button, the ignition phase begins. The display shows START, followed by PELLET IGNITION. The ignition phase typically lasts 5-15 minutes, depending on the type of boiler and the quality of the pellets. During this phase, the pellet feeder, heater, and intake fan are all in operation. The feeder initially loads pellets into the burner for combustion. At the same time, the heater is activated to ignite the pellets, while the intake fan starts to operate and creates the necessary draft for combustion.

When the flue gas temperature sensor detects that the temperature in the chimney has reached the required value, the regulation switches the boiler’s operation to FLAME STABILIZATION.

The FLAME STABILIZATION phase lasts 2-3 minutes (depending on the boiler type), and during this phase, the heater is turned off. After the flame stabilization phase, the boiler transitions to normal operation, gradually increasing the power from level 1 to the desired power level. The display shows OPERATION-POWER. On the right, the power we have set is displayed, and in the last row of the display, the current operating power of the boiler is shown.

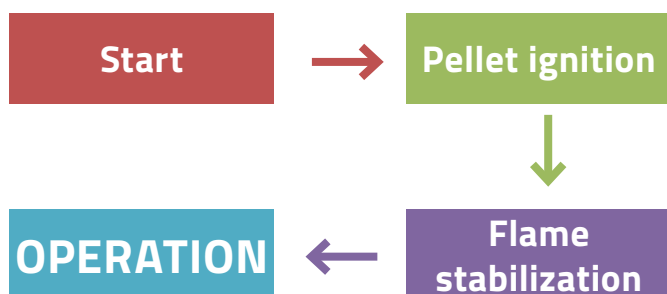

## Schematic representation of the menu on the control system

Pressing the SET button takes us to the main menu.

MENU		VALUE		DESCRIPTION
Menu 01 SET TIME	SET	TABLE NUMBER 1		SETTING TIME AND DATE
Menu 02 SET program	SET	M- 2 - 1 ACTIVATE PROGRAM	TABLE NUMBER 2	PROGRAMMED IGNITION – SHUTDOWN
Menu 03 Language selection	SET	ON / OFF M- 2 – 1 - 01 ACTIVATE PROGRAM		
Menu 04 Standby mode	SET	HR-IT-EN-DE-FR		LANGUAGE SELECTION
Menu 04 Standby mode	SET	ON - OFF		OPERATION MODE OF ROOM THERMOSTAT <ul style="list-style-type: none"> <li>■ BOILER SHUTDOWN (ON)</li> <li>■ MODULATION ( OFF)</li> </ul>
Menu 05 Buzzer mode	SET	ON - OFF		BUZZER ON THE CONTROL SYSTEM WHEN THE ALARM IS ACTIVE
Menu 06 Spiral loading	SET	90 SEC		SPIRAL LOADING WHEN THE HOPPER IS EMPTY
Menu 07 Stove status	SET	ROOM TEMPERATURE, FLUE GAS TEMPERATURE, FAN RPM		BOILER STATUS
Menu 08 Technical settings	SET	FOR SERVICE PERSONNEL ONLY		
Menu 10 Stove cleaning	SET	BUTTON 1 for START		255s FAN OPERATES AT MAXIMUM POWER DURING STOVE CLEANING

**BUTTONS 1 AND 2 - ADJUST  
DESIRED VALUE**

**BUTTONS 5 AND 6 - NAVIGATE  
BETWEEN MENUS**

**BUTTON 3 (SET) - CONFIRM  
BUTTON 4 (ON/OFF) - RETURN  
BACK**

**TABLE NUMBER 1**

MENU 01 SET HOUR	MENU 01 MON DAY	MON - SUN	SETTING THE DAY OF THE WEEK
	08: MENU 01 HOURS SRT	00-24	SETTING THE HOUR
	:33 MENU 01 MINUTE SRT	00-59	SETTING THE MINUTES
	30 MENU 01 DAY HOUR	01-31	SETTING THE DATE
	30 MENU 01 MONTH HOUR	1-12	SETTING THE MONTH
	13 MENU 01 YEAR HOUR	00-99	SETTING THE YEAR

**TABLE NUMBER  
2**

MENU 02 SET PROGRAM									
M-2-1 ACTIVATE PROGRAM	M-2-2 PROGRAM DAY	ON/OFF M-2-2-01 PROGRAM DAY	06:00 M-2-2-02 START 1 DAY	10:00 M-2-2-03 STOP 1 DAY	15:00 M-2-2-04 START 2 DAY	19:00 M-2-2-05 STOP 2 DAY			
	M-2-3 PROGRAM WEEK	ON/OFF M-2-3-01 PROGRAM WEEKLY	06:00 M-2-3-02 START PROG-1	14:00 M-2-3-03 STOP PROG-1	ON/OFF M-2-3-04 MON PROG-1	ON/OFF M-2-3-05 TUE PROG-1	ON/OFF M-2-3-06 WED PROG-1	...	ON/OFF M-2-3-07 SUN PROG-4
	M-2-4 PROGRAM SAT-SUN	ON/OFF M-2-4-01 PROGRAM SAT-SUN	06:00 M-2-4-02 START 1 WEEK END	12:00 M-2-4-03 STOP 1 WEEK END	16:00 M-2-4-04 START 2 WEEK END	22:00 M-2-4-05 STOP 2 WEEK END			
M-2-1-01 ACTIVATE PROGRAM									

**BUTTONS 1 AND 2 - SELECT THE  
TURN-ON OR TURN-OFF TIME**

**BUTTONS 5 AND 6 NAVIGATE  
BETWEEN MENUS**

**WEEK PROGRAM  
(M - 2 - 3)  
HAS THE POSSIBILITY  
OF PROGRAMMING 4 (FOUR)  
TURN-ON AND TURN-OFF TIMES**

## Setting the clock

The clock is set in the following way:

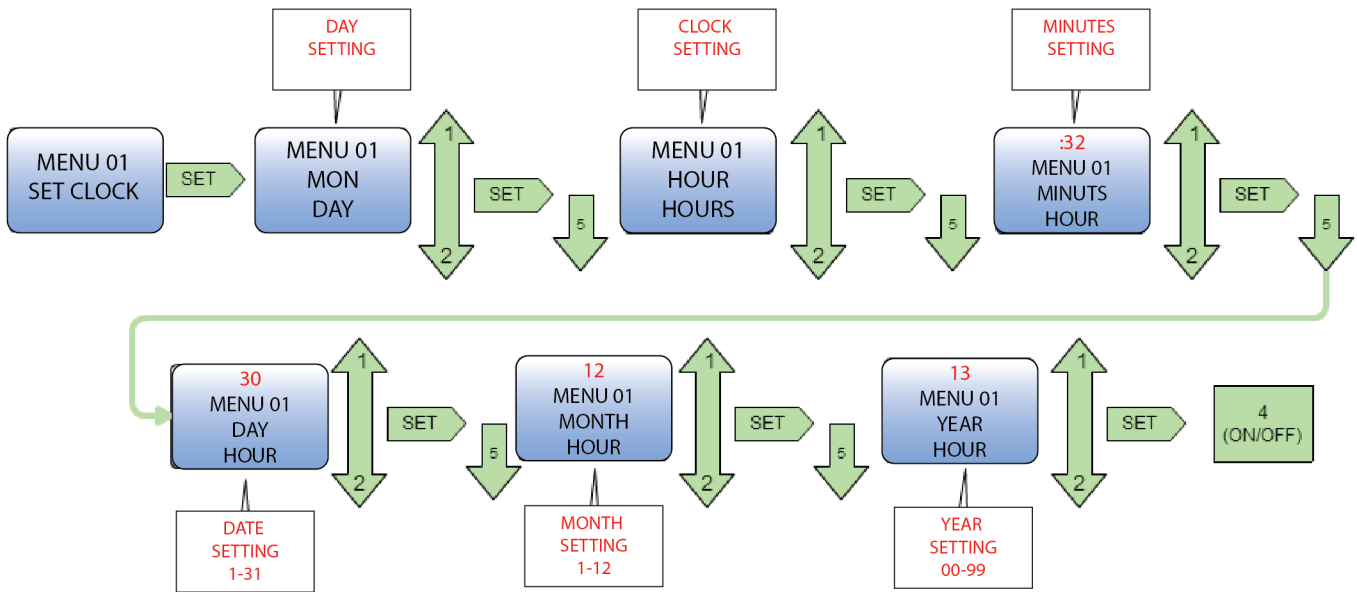

## Setting programmed ignition and shutdown

The boiler has the ability to be programmed for ignition and shut-down during the day, regulated in three ways. (Diagram 1)

DAY PROGRAM, where 2 (two) different ignition and shutdown times for the boiler can be set. This applies to all days of the week. (Diagram 2)

WEEK PROGRAM, where 4 (four) different ignition and shutdown times can be set. In this mode, specific days of the week (MON – SUN) can be selected for each program individually. (Diagram 3)

WEEKEND PROGRAM, where 2 (two) different ignition and shutdown times can be set ONLY FOR WEEKEND DAYS (Saturday and Sunday). (Diagram 4)

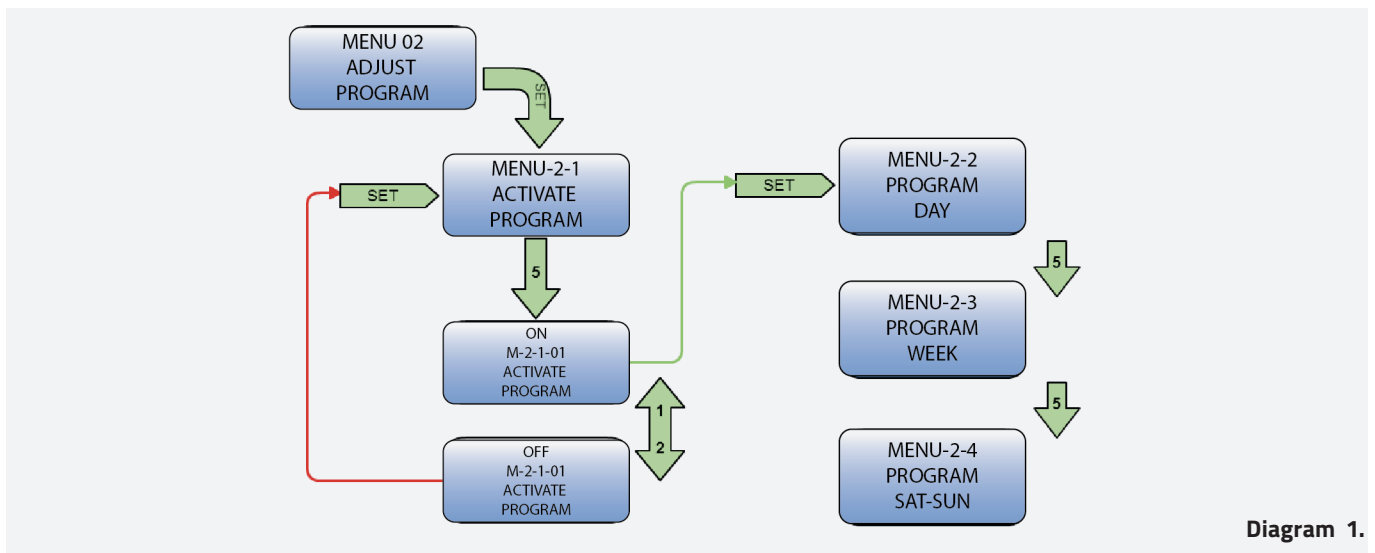

Diagram 1.

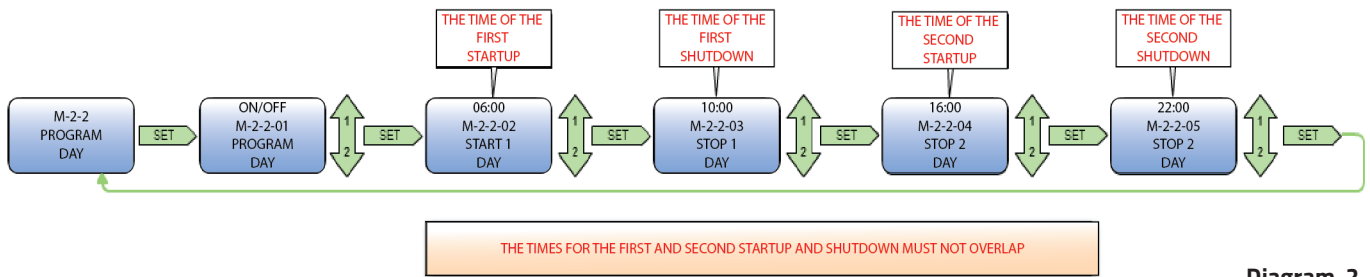

Diagram 2.

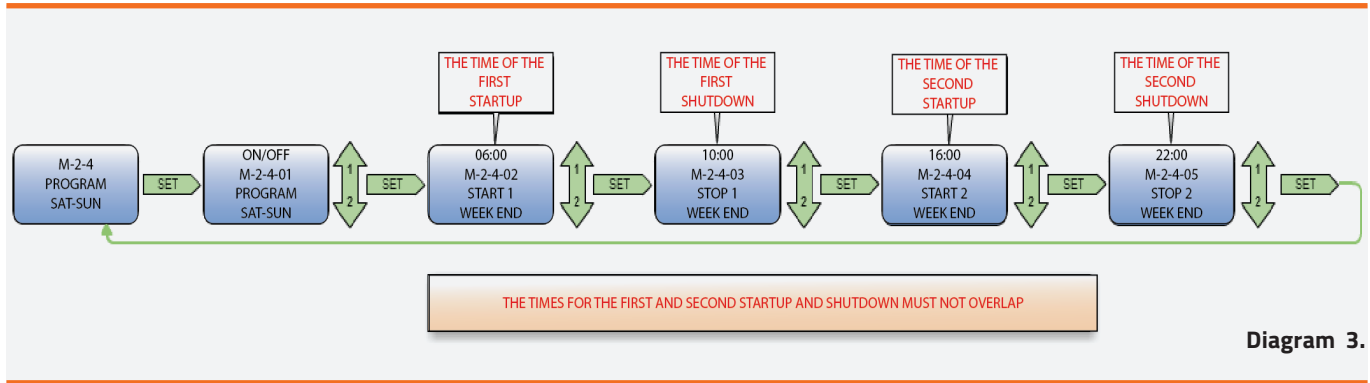

Diagram 3.

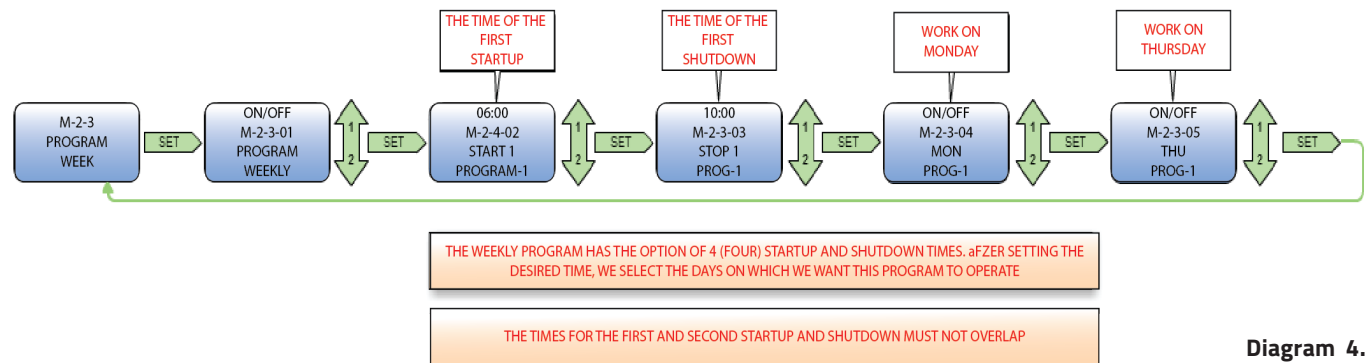

Diagram 4.

## Language selection

Language selection is performed by pressing the SET button, then using buttons 5 or 6 to navigate to menu item MENU 03 – LANGUAGE SELECTION.

Pressing the SET button opens the language selection (Croatian, Italian, English, German, French, Spanish, Portuguese), which is chosen using buttons 1 or 2.

Once the desired language is selected, confirm by pressing the SET button. To return, press button 4 (ON/OFF).

## STAND BY status

STAND BY is used in two ways.

- In case you want the boiler to shut down after reaching the desired temperature (set to ON),
- In case you want the boiler to modulate its operation when it reaches the set temperature (set to OFF).

The STAND BY function can be set to ON or OFF as follows:

Activate the STAND BY mode by pressing the SET button, then use buttons 5 or 6 to select menu item MENU 04 – STAND BY STATUS.

Pressing the SET button opens the ON or OFF selection (choose using buttons 1 or 2, confirm with the SET button).

## STAND BY mode with a built-in water temperature sensor

The room thermostat connection comes from the factory with a jumper, meaning its contact is closed.

## STAND-BY FUNCTION SET TO ON

If the STAND BY function is activated (ON), when the boiler reaches the set temperature and exceeds it by 3°C, the boiler will shut down after a 2-minute delay, which was pre-set at the factory. The display will show tON - WAITING FOR COOLING. If the temperature does not drop below the set value within 4 minutes, the display will show tON - WAITING FOR REQUEST.

When the water temperature in the stove is 3°C lower than the set value, the boiler will re-ignite and operate at the set power.

## STAND-BY FUNCTION SET TO OFF

If the STAND BY function is not activated (OFF) and no jumper is placed on the room thermostat output, the boiler will always operate at power level 1, regardless of the power setting.

If the STAND BY function is not activated (OFF) and a jumper (factory-installed) is placed on the room thermostat output, the boiler will operate at the user-selected power level and will modulate its power once the set temperature is reached. The boiler will only shut down if the system temperature reaches 80°C, and it will restart once the temperature falls below the set value.

## STAND BY mode with a connected room thermostat

### STAND-BY FUNCTION SET TO ON – The room thermostat turns off the boiler

When the room thermostat signals that the desired room temperature has been reached (contact open/temperature reached), the boiler will turn off after 2 minutes (factory setting – to prevent the boiler from constantly turning on and off due to room temperature fluctuations). The display will show tOFF - WAITING FOR REQUEST.

As soon as the room thermostat signals that the room temperature has dropped (contact closed/temperature needs to be reached), the boiler will turn back on, and the display will show tON.

**Note:** The operation of the boiler primarily depends on the internal water temperature in the stove and the factory-set parameters. If the boiler is in **WAITING FOR COOLING** (water temperature has been reached), any request from an additional thermometer will be ignored.

### STAND-BY FUNCTION SET TO OFF – The room thermostat switches the boiler to power level 1

If the STAND BY function is not activated (OFF), the boiler will operate at the user-selected power level, and when the room thermostat reaches the set temperature, it will modulate the power without turning off the boiler.

The boiler will only turn off if the system temperature reaches 80°C, and the display will show WAITING FOR COOLING. It will turn back on when the system temperature drops below the set value.

## The buzzer option

The **BUZZER** option is used if you want the boiler to emit a sound signal in case of an activated alarm (set to ON) or without a sound signal (set to OFF).

To configure the BUZZER mode, press the **SET** button, then use buttons **5** or **6** to select menu item **MENU 05 – BUZZER OPTION**.

Pressing the SET button opens the selection for **ON** or **OFF** (choose using buttons **1** or **2**, confirm with the SET button).

## Filling the spiral

**FILLING THE SPIRAL** is used during the initial pellet loading or when the hopper is completely empty, and it is necessary to fill the spiral of the pellet feeder. It is factory-set to a duration of 90 seconds.

To activate FILLING THE SPIRAL, press the SET button, then use buttons 5 or 6 to select menu item **MENU 06 – FILLING THE SPIRAL**.

Pressing the **SET** button activates the function, and pressing button **1** starts the filling of the spiral.

**It is recommended to empty the pellet hopper and spiral at the end of the heating season because pellets, when left for a long time, absorb moisture from the air. The hopper should be emptied manually, and the spiral should be emptied as described under FILLING THE SPIRAL.**



Before turning on the boiler, check the pellet combustion chamber, as there is a high chance that some pellets may have filled the chamber during the spiral filling process. Empty the chamber and start the ignition process.

## Boiler status

**BOILER STATUS** is for informational purposes and allows us to read the current status of the boiler. On the display, information such as the water temperature in the boiler, flue gas temperature, fan speed, etc., is alternately shown.

To view the BOILER STATUS, press the **SET** button, then use buttons 5 or 6 to select menu item **MENU 07 – BOILER STATUS**.

Pressing the **SET** button activates the status view.

## Technical settings

**TECHNICAL SETTINGS is a section intended only for authorized service personnel.**

# IGNITION AND SHUTDOWN

## Sequence of ignition and regulation description

The basic function of the regulation is to ensure reliable ignition of the fuel, optimal combustion conditions, and controlled shut-down sequence. Depending on the power and complexity of the heating system, parameters are read and controlled differently. Some of the most important modes of operation are described with relevant values. Keep in mind that in some heating systems, the number and value of parameters may differ from the examples provided, but the basic heating system is always the same.

**Before turning on the boiler and putting it into operation, the following should be checked:**

- the hopper should be filled with pellets.
- the pellet hopper lid must be closed.
- the combustion chamber where the pellets burn must be clean.
- the ash pan must be clean.
- all doors on the boiler must be hermetically sealed.
- the boiler must be connected to a 230 V, 50 Hz power supply.

## Ignition

Pressing the button 4  for 3 seconds will start the ignition of the boiler.



The display will show **START**, with the heater and intake fan activated on the left side. The **tON** label indicates that a room thermostat is connected or that a jumper has been installed on the output intended for the room thermostat (factory installed).

Then, the message **IGNITION OF THE PELLETS** will appear on the display, and on the left side, we will see that the pellet dosing is active.



After the pellet ignites, and the flue gas temperature rises to 60°C, the control system receives the signal that the fire is present, and the boiler continues to operate according to the set values.

## Boiler shutdown

To turn off the boiler, press button 4.  hold for 3 seconds. The display will show **FINAL CLEANING**. The intake fan operates at maximum power, while the pellet dispenser stops working.



## Power setting adjustment

During operation, it is necessary to set the power at which we want the boiler to operate.

The power setting can range from 1 to 5, and the desired power is selected using buttons 5 and 6 (\*1). In the top row, the display shows "OPERATION" and the numerical value of the set power (\*2), while in the lower row, on the right, the current operating power of the boiler is blinking (\*3).

Power 1 is the minimum, and power 5 is the maximum.

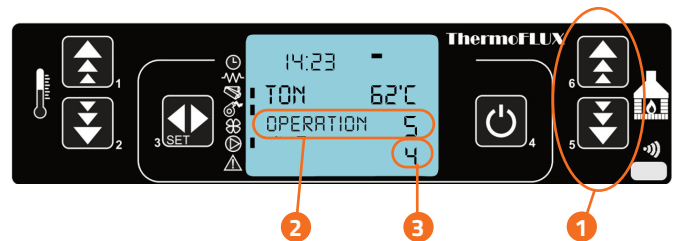

The regulation on the boiler is designed so that 4°C below the set temperature, it starts to modulate its operation (reduce power) – read Modulation.

## Water temperature adjustment

The temperature adjustment is done using buttons 1 and 2 (mark \*1). The temperature in the boiler can be set between 55°C and 80°C, as shown on the display (mark \*2). These are the factory settings, and it is not possible to set a lower or higher temperature in the boiler.

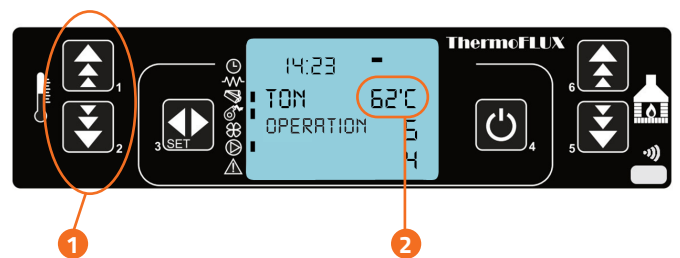

## Modulation

As the water temperature in the boiler approaches the set value, the regulation starts to modulate its operation and sets it to minimal power. Modulation starts 4°C below the set temperature.

For example: If we set the boiler temperature to 65°C and the power to 5, the regulation will work at power 4 when the temperature reaches 62°C, at power 3 when it reaches 63°C, at power 2 when it reaches 64°C, and at power 1 when it reaches 65°C. The display will show MODULATION.

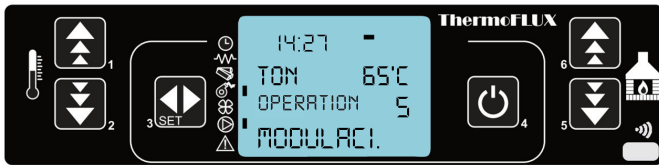

If the temperature increases and exceeds the set value by 3°C, the boiler will automatically turn off, and the display will show WAITING FOR COOLING.



When the temperature in the boiler drops to 3°C below the set value, the regulation will automatically start the ignition process.

## Cleaning of the burner.

The boiler has a timer during operation that performs the cleaning of the burner after a certain period. This phase is displayed on the screen, and the boiler's pellet feeder is set to a lower power, while the intake fan increases power to maximum for a specified time as factory-set.



When the cleaning phase is complete, the boiler will resume operation and set the power back to the selected level.

## CLEANING AND MAINTENANCE

**To ensure smooth operation, the boiler must be cleaned and maintained. Regular maintenance and cleaning help avoid costly repairs.**

**Primarily, the quality of the pellets and the heating intensity determine how often the boiler needs to be cleaned.**

Cleaning is divided into:

- Daily
- Periodic

## Daily cleaning and inspection

### Burner cleaning

- Turn off the boiler and wait for it to cool down.
- Open the boiler doors.
- With a protective glove, remove the container from its housing and empty the contents into a fire-resistant container. Clean the container from combustion residues to ensure unobstructed airflow for efficient combustion. Clean the holes on the container with an appropriate tool to remove any buildup.
- Return the container to its housing, ensuring that it properly aligns with the heater.
- Close the door before ignition.

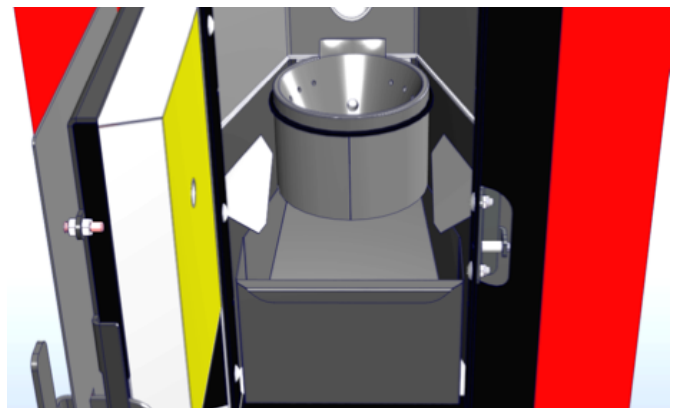

We recommend a vacuum cleaner for cleaning the ash.

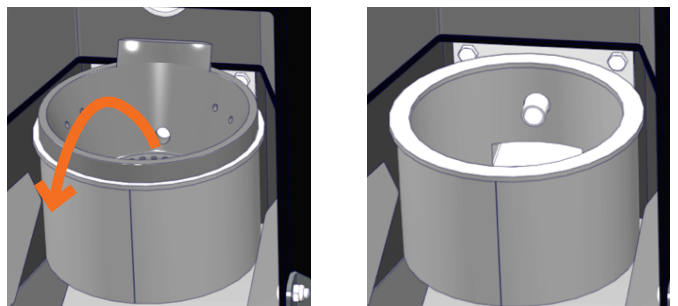

Check for dirt underneath the combustion pot and remove any ash or deposits if present.

## Cleaning the ash container

- Turn off the boiler and wait for it to cool down
- With a protective glove, pull the closing handle downward and open the door, remove the ashtray from the boiler, and empty the contents of the tray into a fireproof container.
- Return the ashtray to its place.
- Close the door before ignition.



## Periodic cleaning of the tubular heat exchanger.

Every 1-3 months, or after consuming 1-1.5 tons of pellets (depending on quality), it is necessary to clean the tubular heat exchanger on the boiler.

If the pellets are not fully burning and the combustion chamber becomes overfilled after a certain operating time, it is time to clean the tubular heat exchangers.

Turn off the boiler and wait for it to cool down.

- 1 Remove the heat exchanger cover by lifting it upward.

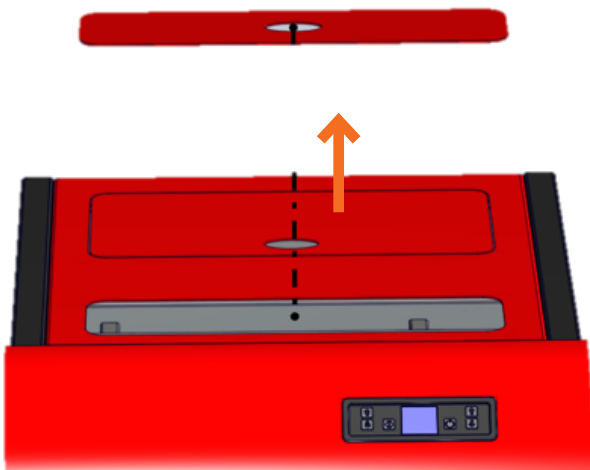

- 2 Under the cover, there are two plates with a spot where the cleaning lever is placed.

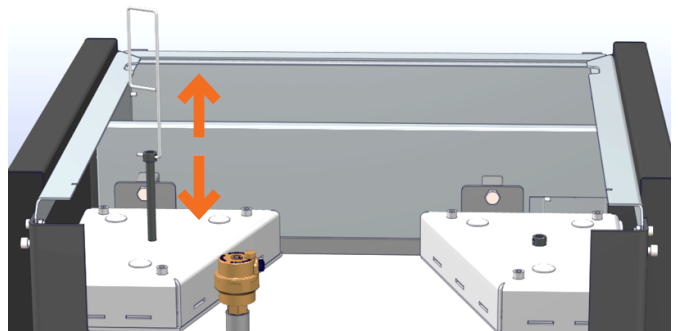
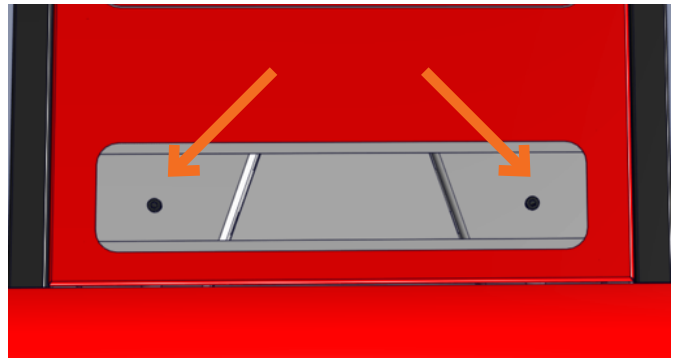

By pulling up and down, we clean the tube heat exchanger of ash deposits.

## Emptying the flue gas chamber of ash

- 1 Inside the combustion chamber (behind the grate), there is a flue gas chamber cover secured with wing nuts

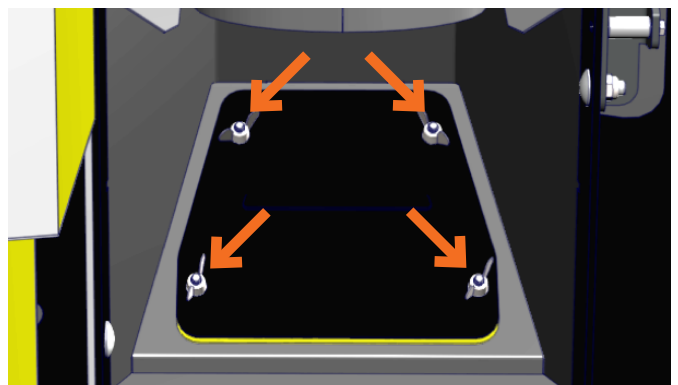

- 2 Remove the cover and remove the accumulated ash in the chamber (preferably with a vacuum cleaner), also vacuum the ash deposits from the fan blades.

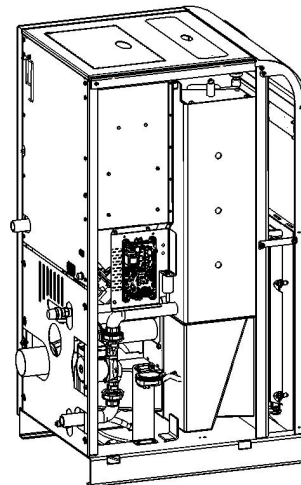
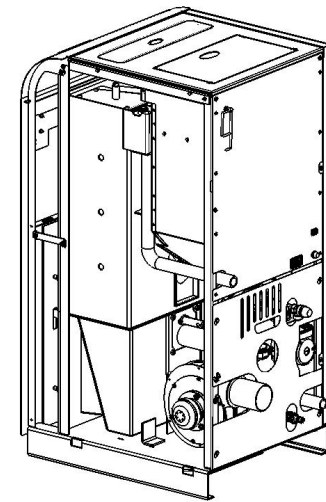
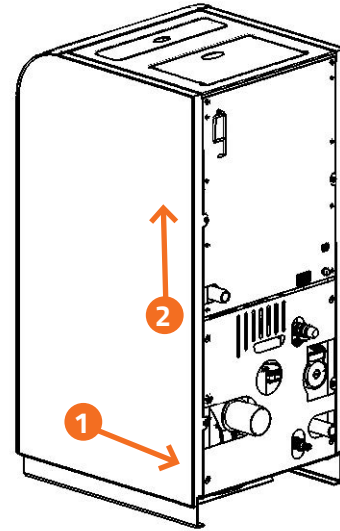
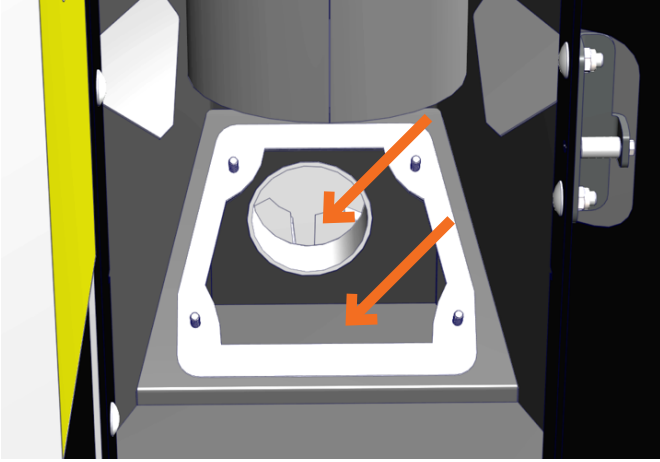

## Removing the side panel

If it becomes necessary to remove the side panel (in case of cleaning flue pipes, unblocking the circulation pump, etc.), the procedure is as follows:

- Unscrew the screws located on the back (ALLEN M5).

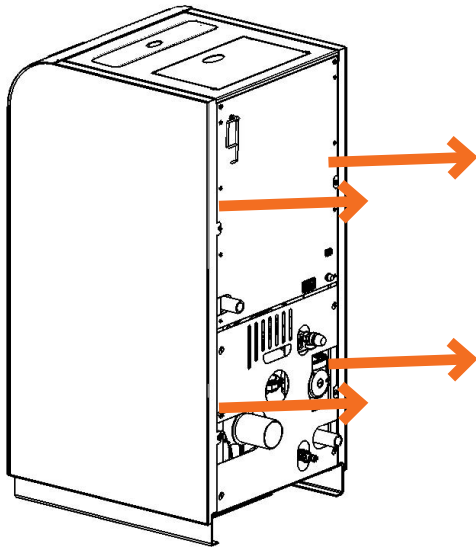

- Pull the casing backward by 20 mm (1), then lift it upward and remove it (2). Repeat the process on the other side.

## ALARMS

DISPLAY	DESCRIPTION	SOLUTION
	Alarm active- indicated next to the sign for alarm	Cancel the alarm can be executed by pressing the button 4  After that, the display lists FINAL CLEANING lasting 4 minutes. After that we can restart the boiler if we solve the problem.
<b>SMOKE SENSOR AL2</b>	The flue gas temperature sensor is faulty or not connected. The boiler displays <b>ACTIVE ALARM</b> and shuts down	Call the service
<b>OVERHEATED FLUE GAS AL3</b>	The flue gas temperature is above the allowed limit (250°C). The boiler displays: <b>ACTIVE ALARM</b> and shuts down	The boiler is not cleaned and the flue gas temperature is above the allowed limit. Clean the boiler and restart the ignition. Excessive pellet feed - Call service.
<b>AIR INTAKE FAN ERROR AL4</b>	Error on the intake fan Stuck fan impeller Faulty encoder (flue gas fan tachometer)	Reset the STB (thermal switch) *see image on page no. 9*  Call service.
<b>IGNITION ERROR AL5</b>	Failed ignition	No pellets in the hopper – add pellets. Auger spiral empty – initial filling. Smoke temperature sensor dirty. Foreign object clogged the auger spiral – clean it. Poor quality of pellets (moist pellets, long pellets, dust in the pellets) – change the pellets. Heater/igniter burned out – replace it – Con- tact service.  Restart the boiler
<b>NO PELLETS AL6</b>	During operation, the flue gas temperature has dropped below the allowed value	No pellets in the hopper – add pellets. Auger spiral empty – initial filling. Foreign object clogged the auger spiral – clean it. Poor quality of pellets (moist pellets, long pellets, dust in the pellets) – change the type of pellets. Contact service
<b>WATER SENSOR AL9</b>	Water temperature sensor malfunction or not connected The boiler displays: <b>ACTIVE ALARM</b> and shuts down	Contact service
<b>SAFETY THERMOSTAT</b>	The safety temperature limiter (STB)* has been activated because the water tempera- ture in the boiler has exceeded 95°C	Wait for the boiler to cool down and then unscrew the plastic cap and reset the switch with a suitable tool. It is possible that the pump is faulty and there is no water circulation. Contact service
<b>POWER SUPPLY INTERRUPTION</b>	The boiler is without power supply	Reset the alarm and restart the boiler

# INSTRUCTIONS FOR REMOVING THE BOILER AND PROPER DISPOSAL.

## Disposal

The following elements are made of iron and can be disposed of at waste disposal sites.

- Boiler
- cover metal sheets
- Silo
- Feeder (except for the motor-reducer)
- Combustion chamber

Electronic components can also be recycled at waste disposal sites.

Glass, mineral wool, and plastic parts can be recycled at waste disposal sites.

Motor reducers are made up of various materials that can be recycled.

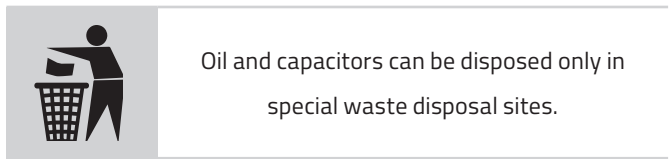

## GUARANTEE

### Guarantee period

The warranty period is 5 years for the metal parts of the boiler and casing, and 2 years for electrical components (regulation and its parts, motors, heater).

ThermoFLUX d.o.o. is responsible for providing service under the warranty conditions in Bosnia and Herzegovina.

In other countries, the warranty is provided by the authorized importer-distributor.

## Warranty conditions/terms

The boiler must be commissioned by a qualified technician authorized by ThermoFLUX d.o.o, or the authorized importer.

The boiler must operate in accordance with the conditions expressed in this manual.

The boiler must be installed in accordance with applicable national regulations and standards.

The quality of the pellets must comply with the standards outlined in this manual.

If the technician commissions the boiler while the necessary conditions are not met, they take full responsibility and cover any additional costs that may arise in case of a malfunction.

## Exclusions from the warranty

The warranty does not cover defects arising from:

- Inexpert and negligent handling or maintenance
- Inexpert and unauthorized opening and repairing of the device
- Incorrect installation, mechanical damage, or overloading not permitted
- Failure to follow the instructions for use
- Failure to follow the instructions for installation and commissioning
- Damage caused by external influences such as fire and water, lightning strikes, excessive voltage, as well as damage incurred during transport.

## EU LABEL

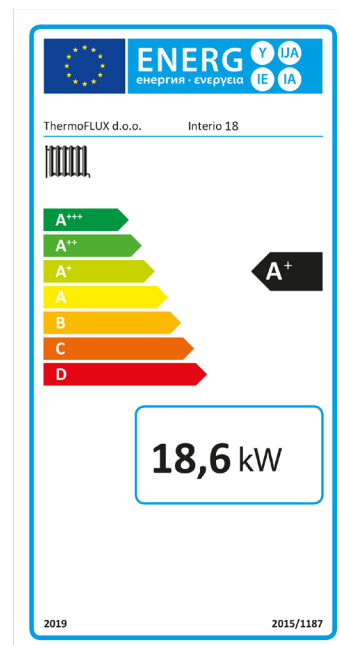

Visit our website [www.servis.thermoflux.ba](http://www.servis.thermoflux.ba) and find out the prices of service services and parts.

**You can find the list of service providers, as well as authorized representatives for other countries, on our website [www.thermoflux.ba](http://www.thermoflux.ba).**





## ThermoFLUX

📍 ThermoFlux d.o.o.  
Bage 3, 70101 Jajce  
Bosna i Hercegovina

☎ +387 30 65 71 00

🌐 [www.thermoflux.ba](http://www.thermoflux.ba)

✉ [tinfo@thermoflux.ba](mailto:tinfo@thermoflux.ba)

📘 ThermoFLUX

